

Understanding how to go at full steam.

Formwork solutions for power plant construction

doka

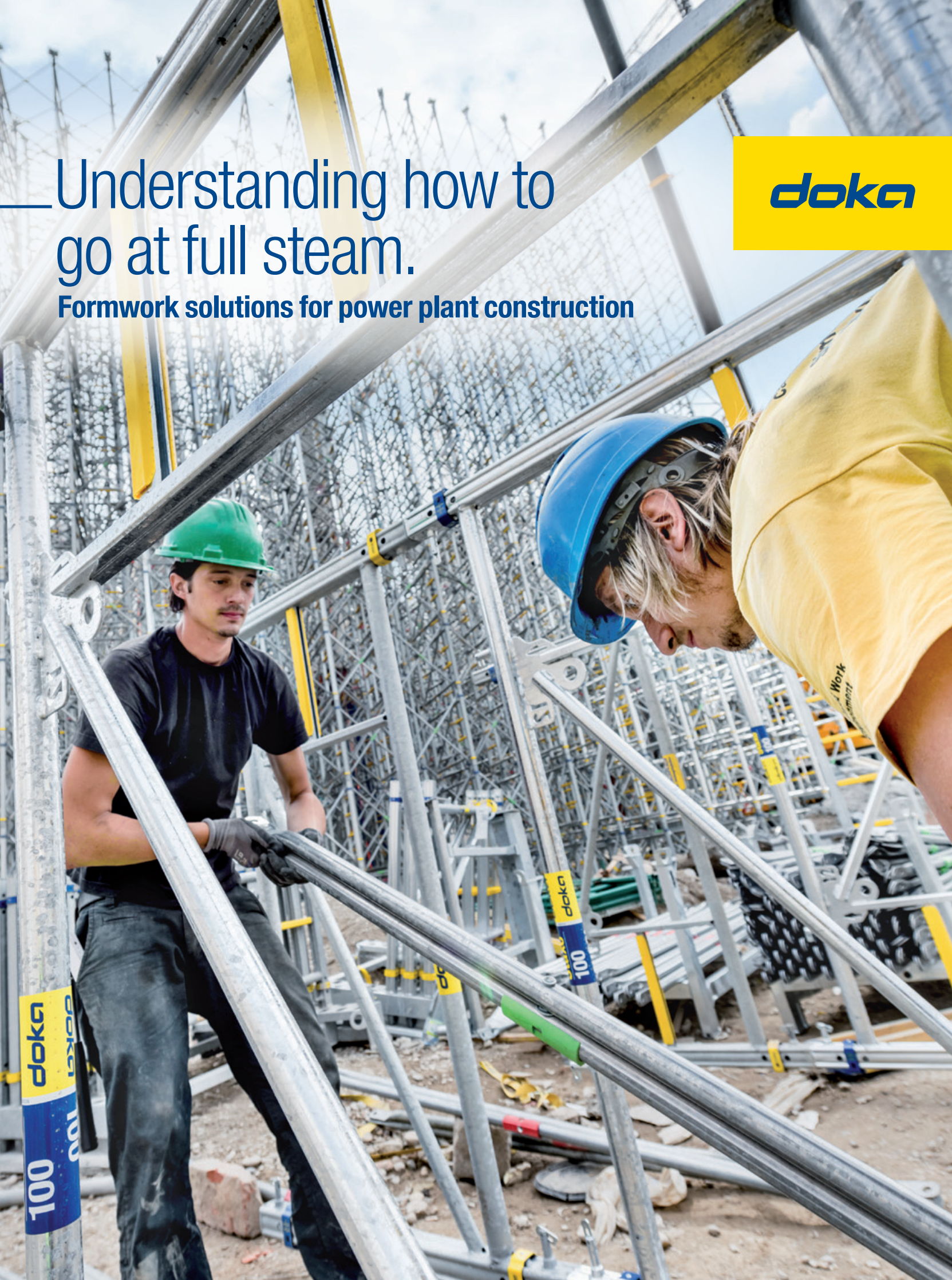

Understanding your energy project as a partner

Amidst the different options in power plant construction, there is one goal at the top of the list: generating energy as quickly as possible. Although the objective is formulated with utmost simplicity, the solutions for getting there are no less challenging. Apart from widely differing geological and topographic conditions as well as special stipulations regarding the concrete there are other major challenges with energy projects including perfectly co-ordinated timing for the different steps and buildings.

Our comprehensive practical experience in power plant construction makes us the right partner at your side: from optimisation of the method and schedule of construction through to the synergies in formwork utilisation and on-site support from our specialists.

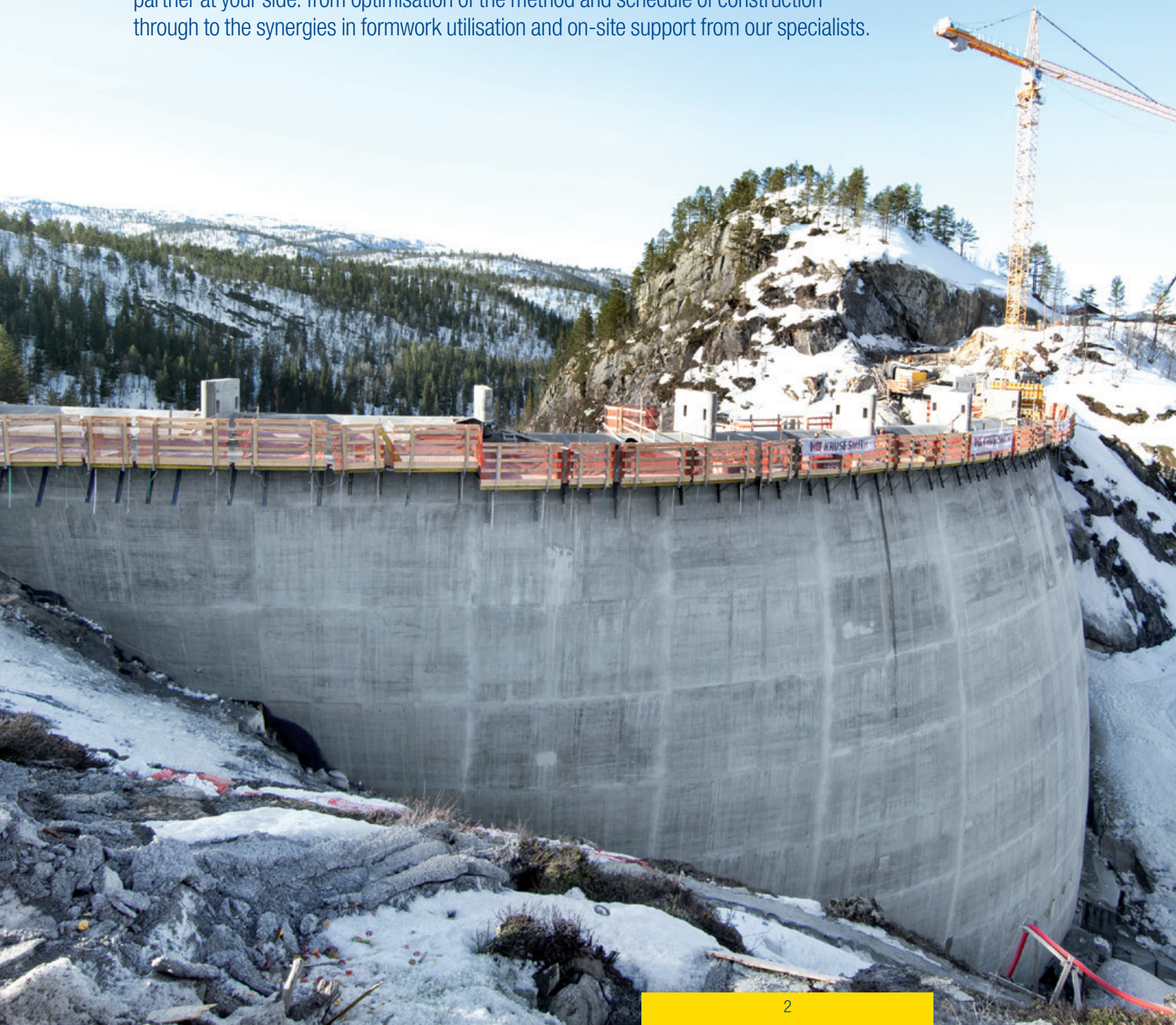



Doka is able to look back on a long history of understanding.

Listening intently, understanding the world as seen through the eyes of our customers, learning to understand all aspects and thinking ahead. We are passionate about not being satisfied with the first solution that might get the job done. Rather, we continue fine-tuning it until we come up with a true benefit for our customers. This is the only way a small woodworking shop could grow into a globally operating formwork company known by the brand name Doka since 1956.



"Without special constructions or additional measures Doka was able to create the Sarvsfossen Dam, a structure that spans 150 m and is 50 m high. Utmost priority was placed on efficient implementation and safety of the construction site crew. Both were achieved to the full extent."

Frank Henning Nedrejord
Site foreman, Kruse Smith AS

Important information: Always observe all relevant safety regulations (e.g. as issued by construction-industry employee safety organisations) applying to the use of our products in the country in which you are operating. In addition, the User Information booklets (Instructions for Assembly and Use), which contain information on standard system set-up and on compliant utilisation of Doka formwork systems, must also be observed. The illustrations in this brochure show the situation during formwork assembly and are therefore incomplete from the safety aspect. It could be dangerous to combine our formwork equipment with equipment from other manufacturers. If you intend to combine different systems, please contact Doka for advice first. We reserve the right to make alterations in the interests of technical progress. © Copyright by Doka GmbH

Understanding requirements

Sound advice begins during the project development stage of a building. Because from this point on, it's all about cost efficiency and having a leg up on the competition. That is why our internationally experienced experts make a point of advising you very early, and very thoroughly.

Doka technicians work to put together the most suitable formwork solutions in combination with high-performing service packages, exactly tailored to each individual construction project and method.

Regardless of how different and unique, one thing holds true for all energy projects: our commitment to the entire project solution has one common denominator – to design a construction workflow that is fast, safe and as good as it can be.

Construction project



WHAT is being built?

Building construction

Based on your project's unique requirements, Doka provides comprehensive solutions for all cast-in-place concrete structures in your energy project. Whether hydro power plants in moving waters, powerhouses, cooling towers or tower structures in case of solar and wind power plants. Doka creates project-specific solutions including system or custom formwork used all over the world.



Geometry of structure

The diversity of the different buildings is also reflected in their geometry. These geometric boundary conditions such as changes in wall cross-section and slope angle, the resulting complexity and the number of pouring sections are crucial for selection of the right formwork systems.



Workflow planning

Observing cycle times has considerable impact on the progress of the entire project. To ensure complete success, detailed planning of system formwork, commissioning quantities, their reuse in additional construction sections within the project and personnel resources are critical.

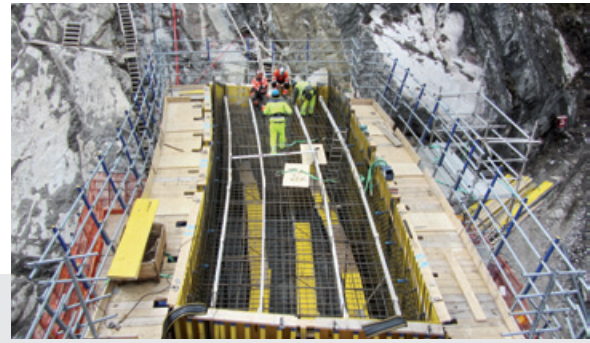

Installation of reinforcement and waterstops

Installing the reinforcement and the waterstops accounts for a significant proportion of the time it takes to build reinforced structures. With a formwork solution designed specifically for your project, you will benefit from the following: generous workspace between reinforcement/waterstop and climbing formwork or for the stop-end formwork of individual pouring blocks when implementing a system solution for dam structures.

HOW is it being build?

Construction method

Safety in every situation

We work with our customers to develop project-specific safety concepts. From concrete monitoring with real-time measuring values or operating and repositioning formwork to stair towers and safeguards through to emergency planning.



Site infrastructure

A smooth and efficient construction process depends on a functioning site infrastructure. Good formwork solutions ease the workload, support concrete placement and provide a sufficient amount of storage space and load capacity.

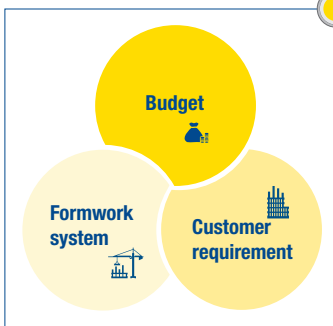

Budget

The investment in quality for formwork systems pays dividends. A solution customised to meet your project's unique requirements saves resources, as well as time and money. We do so through quality-tested formwork systems and a holistic project solution.

_Understanding effective consultation right from the start

Your project success depends not only on selecting the right formwork solutions. Close support of our experts from the start produces a comprehensive solution concept for your energy project. And we provide a single-source from products, services and planning to project management and logistics.





From execution planning to Pre-assembly Service through to shipping logistics: everything has to be co-ordinated to achieve the best project success possible.

**Sohlstufe Lehen power plant,
Salzburg, Austria**



“Every formwork-engineering challenge unleashes energies which drive Doka and their contracting partners to devise exceptional solutions. These allow even the most unusual architectural dreams to become realistic goals.”

Bemmer Andreas
Branch Manager Upper Austria,
Salzburg

_Understanding consultation: In good hands right from the start

With individual consulting services and customised training courses, Doka can help you optimise your workflows at every stage of your project. Project support from the very start simplifies the construction process and allows for best support possible early on in a project.

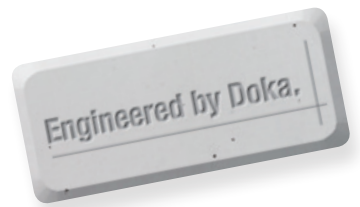

Structural Analysis

The projected structure itself and geometric development over the entire structure, play an important role in selecting the right formwork concept. Only a solution based on fundamental analysis of all the entire project's contract sections supports the best possible construction process.

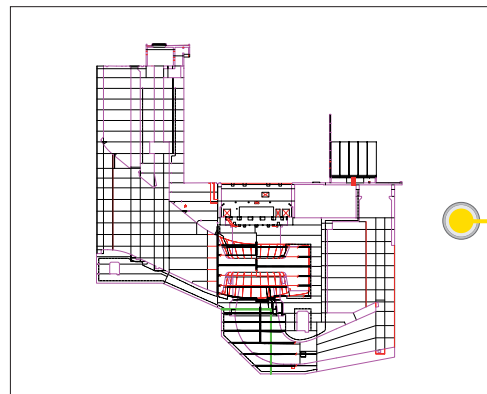

Feasibility study

The right formwork solution developed by our experts at the Competence Center Energy not only includes concepts for all cast-in-place concrete structures but also the services to ensure the project is cost effective.

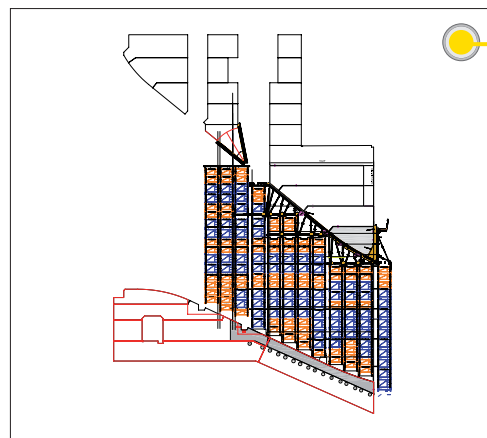

Determining the general conditions

The focused offer planning is based on your site-specific conditions such as project schedule, required cycle time or number and position of cranes.





Invitation to bid & Consultation

- Structural Analysis
- Feasibility study
- Determining general conditions
- Alternative solutions
- Claim management



Alternative solutions

Thanks to many years of experience with power plant construction, Doka looks at problems encountered from a different view. When co-operating with one another, this perspective can lead to alternatives in construction and/or workflow. Examples of this are: modified block heights in conjunction with real-time concrete monitoring, adapted pouring sequence or equipment optimisation by reusing formwork solutions for other structures.



Claim management

Here we advise you and provide documents that are of assistance in submitting and asserting claims for formwork-related supplements vis-à-vis your clients. Specifically, this includes documentation regarding changes and their effects in terms of quantities commissioned and rental periods, additional planning expenses as well as additional costs for shipping, assembly, dismantling and alterations.

_Understanding engineering: Efficient planning for a safe project sequence

Efficient formwork solutions can only be developed economically if there is an understanding of project requirements and construction processes. This understanding is the basis of Doka engineering services.

Engineered by Doka.

BIM – from bid planning through to execution planning

The many formwork solutions in power station construction essentially demonstrate the number of options available for use with the different structures. With the help of BIM in power station construction, formwork solutions can be designed so they are the best fit technically and in terms of efficiency.

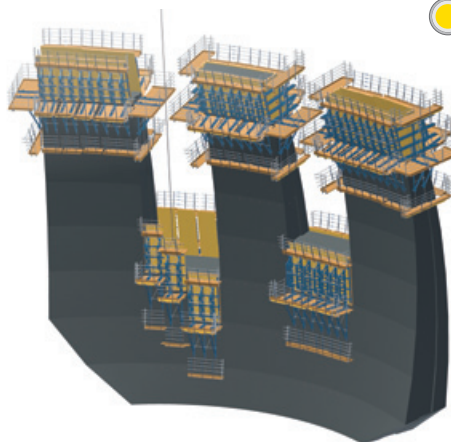

Approval Planning

Final formwork solutions are created based on the most recent version of the planning documents. They are then submitted for discussion and approval.



Execution Planning 2D/3D

The execution planning stage is used to create the plans approved for construction. They include the necessary data for implementing the formwork solution and are created in 2D and, if required, in 3D in accordance with applicable standards and regulations.



Engineering

- BIM
- Approval Planning
- Execution Planning 2D/3D
- Pre-assembly Planning
- Cycle Planning
- Quantities commissioned
- Static Calculations



Pre-assembly Planning

The plans created and approved by Doka provide you with the detailed arrangement of individual parts for a self-assembled fixed formwork unit.

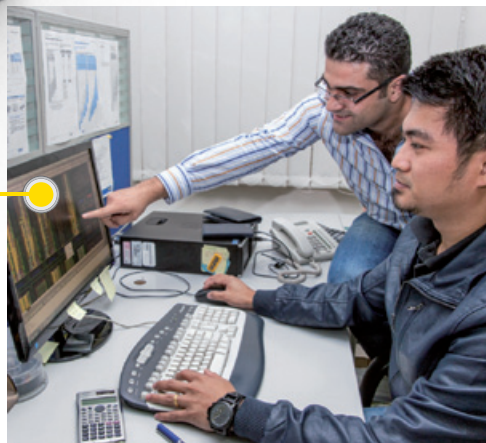

Cycle Planning

When planning the cycles, the pertinent execution plans are created taking into account all specified pouring cycles.



Quantities commissioned

Based on specified pouring cycles and the resulting cycle planning, the optimised formwork quantity is determined for a predefined section.



Static Calculations

Project-related static calculations ensure stability and that the individual formwork unit is suitable for the intended use. Depending on project progress, static calculations range from a simple project structural analysis to exact dimensioning according to local standards incl. documentation (structural analysis) through to certification that they were checked by a civil or testing engineer (verified structural analysis).

_Understanding: Customised formwork solutions

Formwork solutions tailored to meet your needs for all cast-in-place concrete structures from renewable to conventional energy sources as well as tanks and silos.





Formwork solutions for

Renewable energy sources **14**

References 16-27

Conventional energy sources **28**

References 30-35

Tanks and silos **36**

References 38-41

System solutions for

Concrete monitoring **42**

▪ Concremote 42

Vertical structures **44**

- Climbing systems 44
- Wall systems / Large-area formwork 46
- Wall systems / Framed formwork 48
- Wall systems / Column formwork 48
- Wall systems / Supporting construction frame 46
- Safety systems / Working scaffold 46

Horizontal structures **50**

- General conditions for horizontal structures 50
- Load-bearing towers and Floor props 52
- Floor formwork 53

Safety systems **54**

- Stair tower 54
- Ladder system XS 54
- Edge protection system XP 55
- Guard rails 55

Renewable energy sources

Sustainable energy projects for future generations

Renewable energies have the greatest energetic and technical potential of all known energy sources. They are eco- and climate-friendly, can be used globally, are the most cost-efficient energy sources and enjoy an extraordinarily high level of acceptance.

Renewable energies are local energy sources and can replace the usage of coal, petroleum, natural gas and nuclear energies in the power and thermal market step by step. They reduce dependence on energy imports, increase domestic energy output and create jobs.



... Hydro power plants

Special challenges for construction from ...

- building several structures simultaneously
- processing large quantities of concrete in many pouring sections requires precise logistical planning
- challenging dam geometries with changing inclinations to the front and back
- difficult site environment and weather conditions influence concrete temperature, pouring speed, fresh concrete pressure, processing time and concrete placement method
- construction work depends on nature with low and high water levels and meltwaters
- predominant geologic conditions impact construction workflow
- use of concretes with high early-set properties for fast stripping and minimal cycle times
- requirement for superior sealing tightness of concrete body for long-term use with minimal maintenance costs
- high-grade surface finish with simultaneous low tolerances in spillway area as well as inlet and outlet structures

essential structures in cast-in-place concrete:

- inlet structure
- dam body (bulk concrete)
- outlet structure
- draft tube
- spillway

**essential structures in
cast-in-place concrete:**

- foundations
- tower structure

**Special challenges for
construction from ...**

- fluctuations in availability of solar radiation
- exact positioning and orientation of heliostats
- development of high heat in absorber carrier media from 300 to 1,100 °C
- dimensionally accurate tower structure with a height from 50 to 200 m for correct installation of the emulsifying salt store

... Solar energy plants

... Wind mills

**Special challenges for
construction from ...**

- construction in various locations (onshore – on land, offshore – in water)
- strict requirements for accurate dimensions of the tower structure owing to the rotation of the rotor blades
- high wind speeds during construction and operation – with offshore plants in particular there is a short window of time for construction due to the water movement caused by wind
- delivery cycle of turbine and completion of tower structure

**essential structures in
cast-in-place concrete:**

- foundations for onshore and offshore
- tower structure

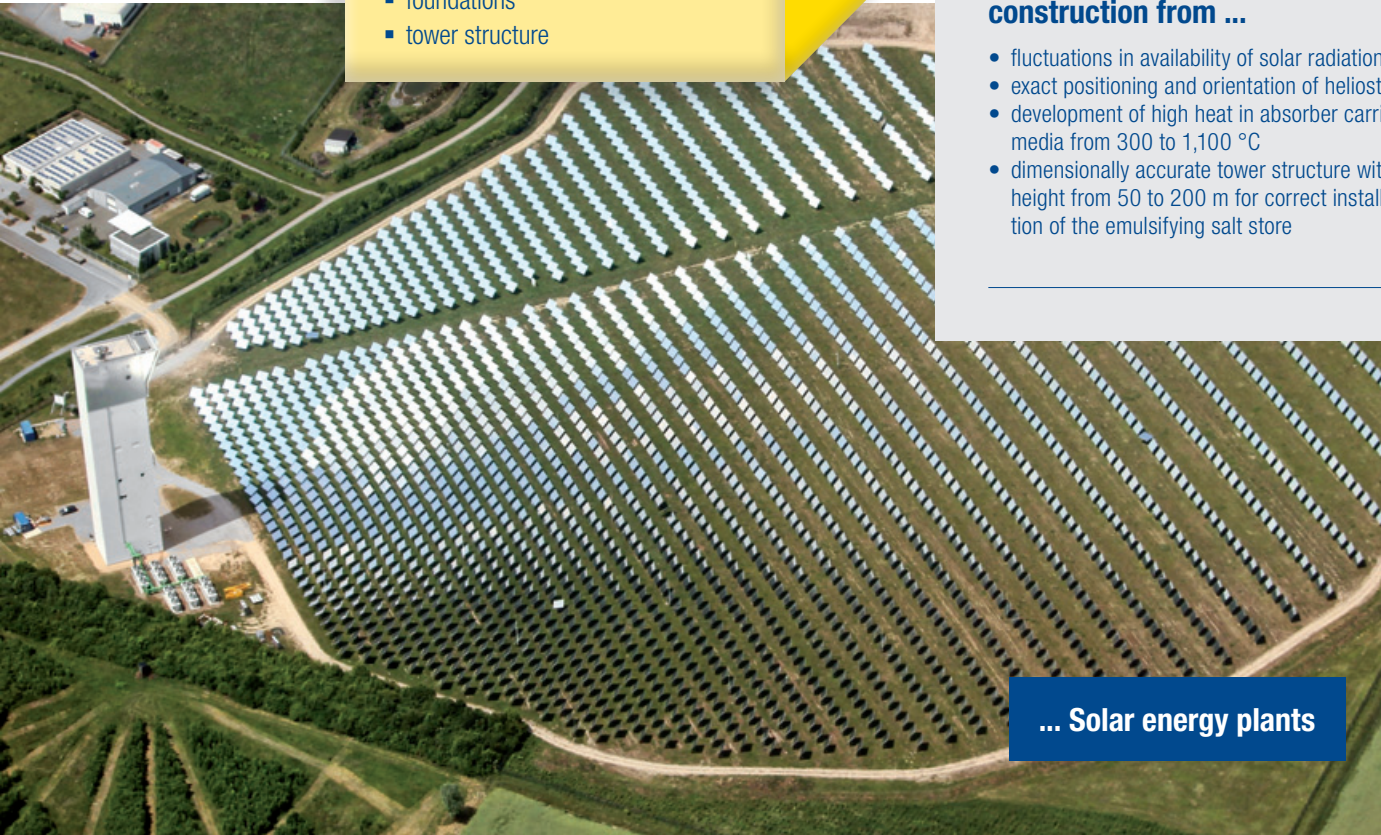

Sohlstufe Lehen Power Plant

Swan-necks above the Salzach. The Sohlstufe Lehen project is characterised by both its unusual architecture located in the midst of the city of Salzburg and also its extreme dimensions.



Challenge:

- erecting the power plant amid running water
- unusual, sculpture-like shapes (swan-necks) of the wier fields
- wier fields 2.50 m wide and walls up to 50 m long



Location: Salzburg, Austria

Construction work: G. Hinteregger & Söhne, Porr Bau GmbH, Teerag Asdag AG

Type of structure: Hydro power plant

Project solution:

- high-level workplace safety during production of the wier field walls ensured by generously dimensioned working platforms that were easily repositioned via crane
- on-time adaptation of formwork solutions even with modifications in the construction process and structural design on short notice
- construction of the power plant in two separate stages
 - the first stage included erecting the wier fields with weir basins and creation of the unusual "swan-necks" using special formwork panels pre-assembled at the plant
 - the second stage involved casting the powerhouse dividing piers for the two Kaplan shaft turbines and the above- or underwater sidewalls with the integrated fish ladder

Products used:

Wall formwork FF20, Large-area formwork Top 50, Load-bearing tower Staxo 100, custom-built platforms, Formwork planning

Construction time: 2010 – 2013



Dam Sarvsfossen

Norway covers nearly its entire energy demand with hydro power. During construction of the arch dam on the Otra River in the Aust-Agder Province, Doka's formwork solution met all requirements. With block heights of 5 m combined with an integrated safety and logistics concept, Dam formwork D35 ensures smooth project success.

Location: Bykle, Norway

Construction work: Kruse Smith

Type of structure: Hydro power plant / arch dam

Facts: 6 m to 7 m thick at the base, tapering to 2.50 m at the top, 150 m long and 50 m high

Project solution:

- optimal adaptation of the inclined structural geometry made possible by Dam formwork D35 for block heights up to 5 m and 37° degree inclination
- climbing scaffold including formwork are quickly repositioned as a single unit
- loads of a concrete placing boom are transferred into the dam formwork system for the duration of the pouring operation
- simple use of standard dam system D35 for pouring the crest of the dam
- safe working conditions in all stages due to closed and generously dimensioned working platforms up to 3.60 m wide
- optimal use of material on-site thanks to the project-specific logistics plan



Challenge:

- more than 40 m banking of Otra River
- arch dam with very small tolerances of 8 mm per 2 m
- dam crest with special design
- utmost safety for the site crew

Products used:

Dam formwork D35, Large-area formwork Top 50, Formwork planning, Formwork Instructor

Construction time: 2012 – 2014



Muskrat Falls

The 824 MW hydro power plant Muskrat Falls in Canada consists of a powerhouse with four turbines, three dam structures, six spillway piers, partition and supporting walls as well as northern and southern operating areas; it is also the second-largest hydro power plant in Canada. Temperatures as low as -40 degrees centigrade on-site are not unusual and present a huge challenge for construction work. Doka provides a formwork solution that is suitable and, with the innovative "Concremote" system, sets new standards when it comes to measuring concrete strength.



Location: Labrador, Canada

Construction work: Astaldi Canada

Type of structure: Hydro power plant

Facts: taking into account the most stringent environmental conditions, LEED certified for sustainable construction

Project solution:

- individually adaptable formwork solutions for different weather conditions that were heated as needed. This made adherence to the construction schedule feasible.
- use of only one load-bearing system on the site thanks to the universal usability of the Load-bearing tower Staxo 100. It is made for economical shoring of thin as well as 4 m thick floors of the powerhouse.
- ladder systems such as stair towers and ladders built into the formwork solutions guarantee safe access routes.
- concrete strength measurement with Concremote for precision monitoring of hydration heat development. Stripping times, treatment times and the time for pre-stressing are derived online directly from the measured values. This allows a construction process that is safe and fast.
- pre-assembled platforms and formwork panels supplied by Doka's Toronto branch helped accelerate the construction workflow and reduce on-site personnel costs
- just-in-time deliveries permitted responding even to workflow changes with short notice
- special formwork for outside walls of the turbines so that steel liner could be affixed without any problems



Products used:

Large-area formwork Top 50, Column formwork Top 50, Dam formwork D22, Load-bearing tower Staxo 100, Framed formwork Framax Xlife, Formwork planning, Formwork Instructor, pre-assembly, Concremote

Construction time: 2014 – 2017



Challenge:

- temperatures as low as -40 °C and constantly changing weather conditions
- due to project size – on-site storage and assembly of formwork on site subject to restrictions
- specially shaped outside walls of the turbines demand that concrete and steel joins seamlessly
- working safely and quickly

Bergeforsen Power Plant

As part of the energy transition and as a result of dismantling all existing nuclear power plants, several hydro power plants are under construction in Sweden - one of them is Bergeforsen. Doka supports this transition to renewable energy sources with a custom-tailored formwork solution in order to supply 147,000 households with energy in the future.

Challenge:

- production of the roughly 17 m high walls without horizontal construction joints
- complex structural geometry
- the only available access had to be kept clear at all times
- very little space as the site is surrounded by 30 m high rock walls



Location: Bergeforsen, Sweden

Construction work: Ellextre Construction Ltd

Type of structure: Hydro power plant / inlet and outlet structure

Height of structure: 23 m

Project solution:

- 3D formwork planning due to complex structural geometry
- unimpeded traffic flow with 5.5 m wide drive-through opening integrated into the Load-bearing tower Staxo 100
- fabrication of precisely fitting complex slab shapes with around 50 different table elements
- "tunnel structure" through difficult rock wall solved with Staxo 100 shoring and a Top 50 top construction

Products used:

Load-bearing tower Staxo 100, Large-area formwork Top 50, Framed formwork Framax Xlife

Construction time: 2011 – 2013





Challenge:

- space is at a premium on the site with little room for storage
- strict structural tolerances with < 5 mm off centre and < 8 mm off height
- many different shaft layouts
- protruding installation structures that partially extend into the formwork
- formwork solution for fixed concrete pump area required

Dam Three Gorges

The ability to navigate the Yangtze Kiang has always been limited by great fluctuations in the depth of its water level. The new construction will raise the water level in this area of the dam by roughly 70 m. The ship lift at the Three Gorges Dam is the world's largest up to now. With a total lift of 113 m and a lock lift capacity of 11,800 tons (water and freight), the ship lift is equipped for the future.

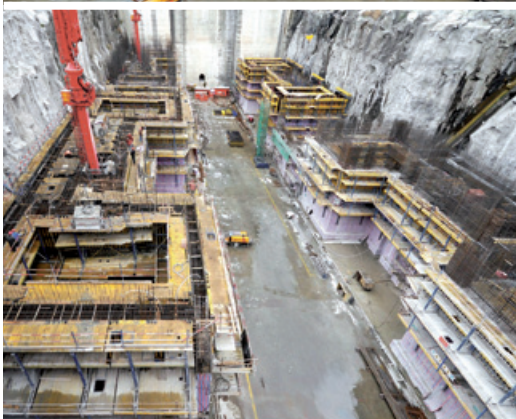

Location: Hubei region, China

Construction work: China Gezhouba Group Corporation (CGGC)

Type of structure: Hydro power plant / ship lift

Facts: 200,000 m³ concrete used in the structure

Project solution:

- formwork solution with special steel formwork and Climbing scaffold SKE50 adapted to the special conditions such as structural geometry and tolerances as well as existing installation parts
- shorter crane times also in the shaft with automatic climbing formwork
- timely planning and delivery thanks to provision of logistics team
- instruction and support for the site crew by experienced Formwork Instructors

Products used:

Automatic climbing formwork SKE50, Large-area formwork Top 50, special steel formwork

Construction time: 2009 – 2012



Challenge:

- minimising casting joints with extra-high casting sections
- size and complexity of the project required large quantities of materials
- use of water stops in places difficult to access

Waaslandhaven Deurganckdok Lock

The new Deurganckdok lock is under construction on the left bank in the Antwerp Harbour and is expected to be completed in March 2016. For this project Doka supplied an optimised formwork solution and supported construction from the early stages of planning through to completion. This is how unusual specifications could be implemented with ease.

Location: Antwerp, Belgium
Construction work: THV Wasslandsluis JV
Type of structure: Lock
Facts: Structure height 28 m

Project solution:

- thanks to the use of Dam formwork D22 with rising working platforms anchored block heights of 8 m could be poured
- the integrated ladder system allows quick working on 5 platform levels at once
- using standard parts designed for easy utilisation reduces equipment costs
- best possible use of equipment on site thanks to Doka logistics planning

Products used:

Supporting construction frame, Circular formwork H20, Large-area formwork Top 50, Framed formwork Framax Xlife, Edge protection system XP, Load-bearing tower Staxo 100, Dokaflex, Dam formwork, Climbing formwork MF240

Construction time: 2012 – 2016



Dam Tsankov Kamak

The Tsankov Kamak hydro power plant is located in the south of Bulgaria. Its 80 MW of installed capacity is used to supply the surrounding region. The arch dam is 130 m high and 468 m long. In addition to the dam, Doka was also responsible for formwork solutions for the spillway channel and access tunnels.

Challenge:

- planning for use of customer-owned and Doka rental equipment
- use of water stops in places difficult to access
- optimising workflow for accelerated construction progress
- building temporary tunnels and bridges for construction site development at 1000 m above sea level
- formwork pre-assembly directly on site due to the long distance for transport



Location: Bulgaria
Construction work: Alpine Mayreder
Type of structure: Hydro power plant / arch dam
Facts: Height 130 m, Length 468 m, block volume from 600 – 2400 m³

Project solution:

- cost savings due to execution planning coordinated with customer-owned materials
- clear, straightforward formwork concept made of only three different Large-area formwork Top 50 panels with built-in water stop solution
- detailed cooperation ahead of time between contractor and Doka specialists aimed at optimising the construction workflow
- Doka as the single-source supplier – even formwork equipment for temporary service routes such as bridges and tunnels was provided by Doka
- logistics consultation and planning for on-site formwork pre-assembly to achieve optimal resource utilisation
- erection scaffold planned and implemented so that panels could be assembled quickly

Products used

Large-area formwork Top 50, Dam formwork D22

Construction time: 2004 – 2011

Muttsee Dam

Challenge:

- forming and pouring operations at 2,500 m above sea level
- structure consisting of a two-part angled gravity dam with built-in spillway
- inclination of 1:0.8 on downstream side

Construction of the Muttsee dam at nearly 2,500 m elevation is one of the key structures of the pumped storage power plant Linthal 2015. At 1,025 m long, the dam will be the longest in Switzerland.



Location: Muttsee, Linthal, Switzerland
Construction work: Marti Tunnelbau AG, Marti AG, Marti Technik AG, Toneatti AG
Type of structure: Hydro power plant / dam
Facts: 1,025 m long and at nearly 2,500 m above sea level

Project solution:

- taking into account the unusual weather conditions at 2,500 m above sea level in planning and selection of the formwork system
- a total of 68 blocks, each 15 m long with crests from 4 m to 6 m wide were completed on time by using Dam formwork D22
- tilting the Dam formwork D22 allowed problem-free and rapid adaptation to the dam's requirements for inclination
- sufficient space for preparing the suspension points for the next casting step thanks to the option for tilting

Products used:

Dam formwork D22, Large-area formwork Top 50

Construction time: 2010 – 2016



Challenge:

- production of hollow bodies made of cast-in-place concrete onshore and subsequent lowering into the water up to 27 m deep
- special shape of gravity foundations: 50 cm thick, cone-shaped cast-in-place concrete casing up to 17 m high; following a 1 m transitional area, the casing turns into a 23-m high cylinder
- production of a 6 m long horizontal cantilever at the top

Thornton Bank Wind Farm

One of the largest wind farm projects anywhere in the European Union is located 30 km off the Belgian coast. Its 60 wind turbines will generate approx. 1,000 GW/h of electricity annually and cover the electricity needs of 600,000 residents. Doka supplied the formwork solution for the gravity foundations of the wind turbines.



Location: Belgium
Construction work: M.B.G.
Type of structure: wind farm / offshore
Facts: 6 formwork sets for 60 wind turbines

Project solution:

- fast and easy forming of the cylindrical shaft of the cast-in-place concrete casing using the Climbing formwork MF240
- creation of the special form for the gravity foundations thanks to project-specific Doka Pre-assembly Service panels
- use of custom-tailored panels of the Large-area formwork Top 50 for the cast-in-place concrete casing
- 8 m high supporting construction frames were used on their sides to produce the 6 m long horizontal cantilever at a height of more than 40 m. The triangular shape of the supporting construction frames reliably transfers the vertical loads from the fresh concrete into the casting steps below.

Products used:

Climbing formwork MF240, Large-area formwork Top 50, Pre-assembly Service, supporting construction frame

Construction time: 2008 – 2013



Challenge:

- tight construction schedule (1 month per tower)
- 1-day cycle
- use and cycling of several formwork sets
- reinforcement operations required independent of formwork system
- casting-section heights from 4 to 5 m

Location: Aulepa, Estonia

Construction work: Skanska Finland

Type of structure: wind farm / onshore

Hub height: 100 m

Facts: 13 turbines each rated at 3 MW

Project solution:

- acceleration of construction time with simultaneous use of 4 formwork sets
- formwork and scaffold structures are easily transported between the towers
- fast and safe formwork solution that can be adapted to the different tower diameters
- pre-assembled reinforcement on ground level in order to speed up the building progress
- easily pre-stressed wind turbines

Products used:

Large-area formwork Top 50, Doka tower formwork for wind power plants, steel formwork

Construction time: 2008 – 2009

Aulepa Wind Farm

The Aulepa wind farm in Estonia is an onshore wind farm with 13 wind turbines. It generates 3 MW at 100 m hub height per wind turbine. Complying with the tight construction schedule in very difficult weather conditions of the Estonian winter presented major challenges.





Challenge:

- tight construction schedule
- safety of site crew
- high wind speeds

Location: Jülich, Germany

Construction work: Ed. Züblin AG

Type of structure: Solar power plant / tower structure

Height: 60 m

Project solution:

- thanks to the Guided climbing formwork system Xclimb 60, the 14.85 m x 9.60 m cross-section of the 60 m tall solar tower grew taller in a weekly cycle
- Each climbing unit has one working, pouring and follow-up platform. In combination with the Ladder system XS, this configuration helps maximise safety for the site crew.
- Shoes mounted to the structure guide the scaffolds' vertical climbing profiles. It takes only a single crane lift to pull the climbing units upward at wind speeds up to 70 km/h.

Products used:

Climbing formwork MF 240, Guided climbing formwork Xclimb 60, Shaft platform, Large-area formwork Top 50

Wall formwork FF20 / Ladder system XS

Construction time: 04/2008 – 10/2008

Jülich Solar Power Plant

The only one of its kind anywhere in the world, a unique solar power plant with planned output of 1.5 megawatts went on-grid in Jülich near Aachen at the end of 2008. To be sure of staying on schedule with the 60 m tall tower structure even in bad weather conditions, contractors Ed. Züblin AG used Guided climbing formwork Xclimb 60.



Conventional energy sources

Gas, coal and co. for consistent generation of energy

Currently a large portion of the energy demand is covered by conventional energies. Conventional energies include oil, gas and coal. These energy sources were created many millions of years ago from remains of plants and animals. One advantage of conventional energy sources is that they are available for generating energy regardless of weather, time of day and seasons.

Energy generation from conventional energy sources has many faces. The common denominator in construction projects for oil-fired and coal-fired power plants is their special logistical demands arising from the different contract sections in these large-scale projects. Here it is crucial to keep track of everything and optimise the methodology of construction.



... Coal-fired power plants

Special challenges for construction from ...

- working in tight spaces with many buildings requires precise plans for workflow and schedules
- high volumes of equipment due to varying structures
- tight schedule for project implementation requires short pouring cycles
- structures built to high-quality standards for a long lifespan and assurance of trouble-free operation
- different requirements for concrete due to exposure to solid, liquid and gaseous substances
- highly demanding geometries especially with turbine stands



**essential structures in
cast-in-place concrete:**

- powerhouse
- foundations
- silo | bunker | tank
- turbine stand
- chimney
- cable tunnel
- cooling tower



... Gas-fired power plants

Timelkam Combined-Cycle Gas Turbine Power Plant

To continue catering for the region's ever-increasing electricity needs with minimum environmental impact, Austrian utility Energie AG had a new combined-cycle gas turbine plant built at Timelkam, 40 km east of Salzburg. The cast-in-place walls of the 48 m high stair tower were formed using Automatic climbing formwork Xclimb 60.



Challenge:

- short-term project with construction sections on differing cycles (stair tower 4-day cycle, lock 2-day cycle)
- tight schedule for formwork pre-assembly
- limited lifting capacity with only one slewing tower crane

Location: Timelkam, Austria

Construction work: Alpine Mayreder, Porr AG

Type of structure: Combined-cycle gas turbine power plant / stair tower / lock

Height of structure: 48 m

Project solution:

- Automatic climbing formwork Xclimb 60 for the 48 m tower structure to free up crane capacity
- increased site crew productivity thanks to on-site support from a Doka Formwork Instructor for pre-assembly of the Framax Xlife panels and Xclimb 60 climbing platforms
- certainty of schedule and costs by using a formwork solution that is easy to operate and making the optimal quantities commissioned available

Products used:

Automatic climbing formwork Xclimb 60. Shaft platform
Framed formwork Framax Xlife, Stair tower 250, Ladder system XS

Construction time: 02/2007 – 07/2007





Eemshaven Hard-coal-fired Power Plant

A modern hard-coal-fired power plant with a gross output of 1600 MW was built within just four years at Eemshaven in the Netherlands. Doka supplied cost-saving formwork solutions for the turbine building, silo building, steam generator plant and main switchgear building.

Challenge:

- high wind speeds with up to force-8 gusts result in limited opportunities for crane use
- different buildings and plants increase complexity of project
- cost-saving overall solution to keep within the construction schedule while saving time and money



Location: Eemshaven, Netherlands

Construction work: Mainka and Visser & Smit Bouw (JV VIMA VOF)

Type of structure: Hard-coal-fired power plant
Turbine building, silo building and steam generator plant, main switchgear building

Project solution:

- safe repositioning of climbing scaffold at wind speeds up to 70 km/h thanks to guided climbing formwork for the turbine building's core walls formed and poured in advance
- Doka Engineering planned all structures using Doka's modular systems – including the tried and tested Edge protection system XP for securing formwork and floor drop-off edges
- certainty of costs, schedule and quality thanks to coordinated overall formwork concept and on-site support from Doka Formwork Instructors

Products used:

Framed formwork Framax Xlife, Guided climbing formwork Xclimb 60, dam formwork, Load-bearing tower Staxo 100, Edge protection system XP

Construction time: 2008 – 2012



Damodaram Cooling Tower

128 climbing units of the Cooling tower formwork SK175 are climbed automatically to a height of 172.50 m. The cooling tower's diameter at the ground is 132.10 m and tapers to 76.40m at the waist point before finally increasing again to 77.40 m at the topmost edge. Thanks to the formwork solution supplied by Doka, a 1-day cycle was achieved.

Location: Krishnapatnam, India
Construction work: Tata Projects Ltd.
Type of structure: Coal-fired power plant / cooling tower
Height: 172.50 m
Maximum diameter: 132.10 m
Cycle time: 1-day cycle

Project solution:

- the detailed workflow plans elaborated by Doka engineers permitted a 1-day cycle, ensuring on-time progress on this build.
- special training for construction management and the majority of the construction crew ensured the project got off to a smooth and safe start
- easy adjustability of the Cooling tower formwork SK175 enabled compliance with the low tolerances specified in every casting step.

Challenge:

- adherence to tight construction schedule
- easy and safe handling of formwork solution
- very small tolerances for pouring

Products used:

Cooling tower formwork SK175, Doka Formwork Instructor

Construction time: 2012 – 2014





Challenge:

- project solution for the entire cooling tower (foundation, columns, shell up to the top walkway, flue gas opening)
- 1-day cycle



Šoštanj Cooling Tower

The environmental retrofit of the Šoštanj coal-fired power plant aims to cut greenhouse gases and CO² emissions by around 35 percent. With the Cooling tower formwork SK175, Doka helped the client build the new cooling tower quickly, safely and efficiently.

Location: Šoštanj, Slovenia
Construction work: Primorje
Type of structure: Coal-fired power plant / cooling tower
Height: 164.50 m
Maximum diameter: 94 m
Cycle time: 1-day cycle

- Project solution:**
- support for contractor / designer regarding the design of the cooling tower
 - consultation in terms of required site crew capacities for efficient construction start and progress
 - ongoing operations even at low temperatures in winter thanks to built-in steel formwork insulation
 - use of the automatic climbing formwork on the cooling tower's inside wall eliminates the need for additional formwork equipment for creating the top walkway

Products used:
 Cooling tower formwork SK175, Column formwork Top 50, Load-bearing tower Staxo 100

Construction time: 2011 – 2012

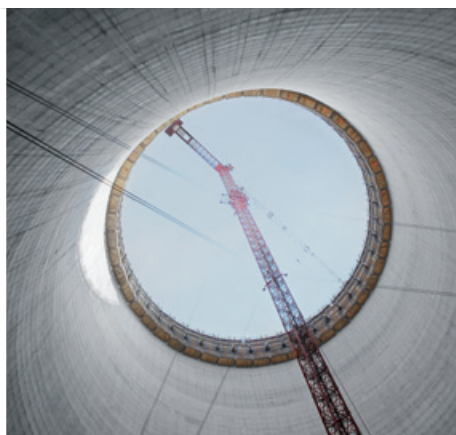



Challenge:

- project solution for the entire power plant (except cooling tower)
- on-time delivery of large formwork quantities
- detailed advanced planning is needed when work takes place simultaneously on different construction sections
- strict safety requirements
- very small structural tolerances for the turbine stand

Neurath lignite-fired Power Plant

The twin-unit plant with 1,100 MW capacity per unit is the second power plant of its kind worldwide. Doka supplied formwork systems for the slit bunker, the two boiler houses and the main switchgear building. These challenges were successfully tackled with reliable Doka custom-built constructions which greatly simplified the construction workflow.



Location: Grevenbroich-Neurath, Germany
Construction work: Ed. Züblin AG, Alpine AG
Type of structure: Coal-fired power plant

Project solution:

- support for site crew by a Doka Formwork Instructor so that the different formwork systems can be handled more easily
- certainty of schedule and quantity with just-in-time delivery of large amounts of formwork materials from nearby Doka branch
- fast forming of the slit bunker partition walls thanks to pre-assembled Wall formwork FF20 for pouring step heights of 7.2 m
- tailor-made formwork solution even with complex structural geometries due to the flexible modular Large-area formwork Top 50 system
- safe working conditions at the slab edge by erection of temporary working platforms

Products used:

Wall formwork FF20, Large-area formwork Top 50, Folding platform K, Heavy-duty supporting system SL-1, Climbing formwork MF240, Load-bearing tower Staxo 40 and Staxo 100

Construction time: 2006 – 2011

Ledvice Cooling Tower

The cooling tower of the Ledvice power plant has a diameter of 98 m. Up to the waist, it tapers to around 68 m. The construction required a total of 100 climbing units of the Cooling tower formwork SK175. The structural height of 136 m was achieved in 93 pouring sections.

Challenge:

- tight construction schedule – 4 months to produce foundation, columns and rings 1 to 3 of cooling tower shell
- production of cast-in-place columns with self-compacting concrete
- 1-day cycle
- straightforward formwork solution for flue gas opening



Location: Ledvice, Czechia
Construction work: Reko Praha a.s.
Type of structure: Coal-fired power plant / cooling tower
Height of structure: 145 m
Maximum diameter: 98 m
Cycle time: 1-day cycle

Project solution:

- cycle planning and just-in-time delivery of formwork units for foundation, columns and rings 1 to 3, so that pouring operations can be finished before winter season
- on-site support with assembly of the self-climbing formwork units by Doka Formwork Instructors during the winter months in order to adhere to the construction schedule
- flexible design of the formwork solution for the cast-in-place concrete columns – designed for standard as well as self-compacting concrete
- consultation for capacity planning with respect to daily rhythm and crew size – the daily cycle was achieved with 5 independent teams (crews for stripping, climbing, forming, reinforcing and pouring)
- pouring a temporary thin wall for the flue gas opening in order to save time and money

Products used:

Cooling tower formwork SK175, Large-area formwork Top 50

Construction time: 2009 – 2011

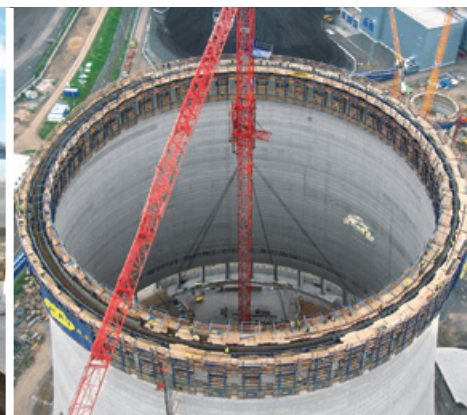

Tanks and silos

Warehousing and storage of solid, liquid and gaseous substances

Tanks are defined as containers for storing or shipping gases and liquids. Typically, in order to have these substances ready for loading and unloading, tanks are built near the coast close to marine terminals. Depending on requirements, tanks consists of one or two cast-in-place concrete walls transferring the load, while the inside wall is equipped with a steel liner.

Silos are storehouses for bulk materials like cement, powdered limestone, plastic granules or foodstuffs and fodder. Common shapes of silos are round, rectangular and octagonal.

Special challenges for construction from ...

- high wind speeds near the coast
- separation of structure and foundation due to special storage in regions subject to earthquake risks
- installation of steel construction for dome structure
- strict requirements for sealing tightness of steel-concrete composite construction as liquid and gaseous substances are stored
- tank walls are pre-stressed vertically and horizontally
- concrete placement due to the high level reinforcement and large number of jacket tubes
- limited crane capacities resulting from large tank diameter up to 80 m

essential structures in cast-in-place concrete:

- upper pressure ring
- walls
- foundations

... Tank

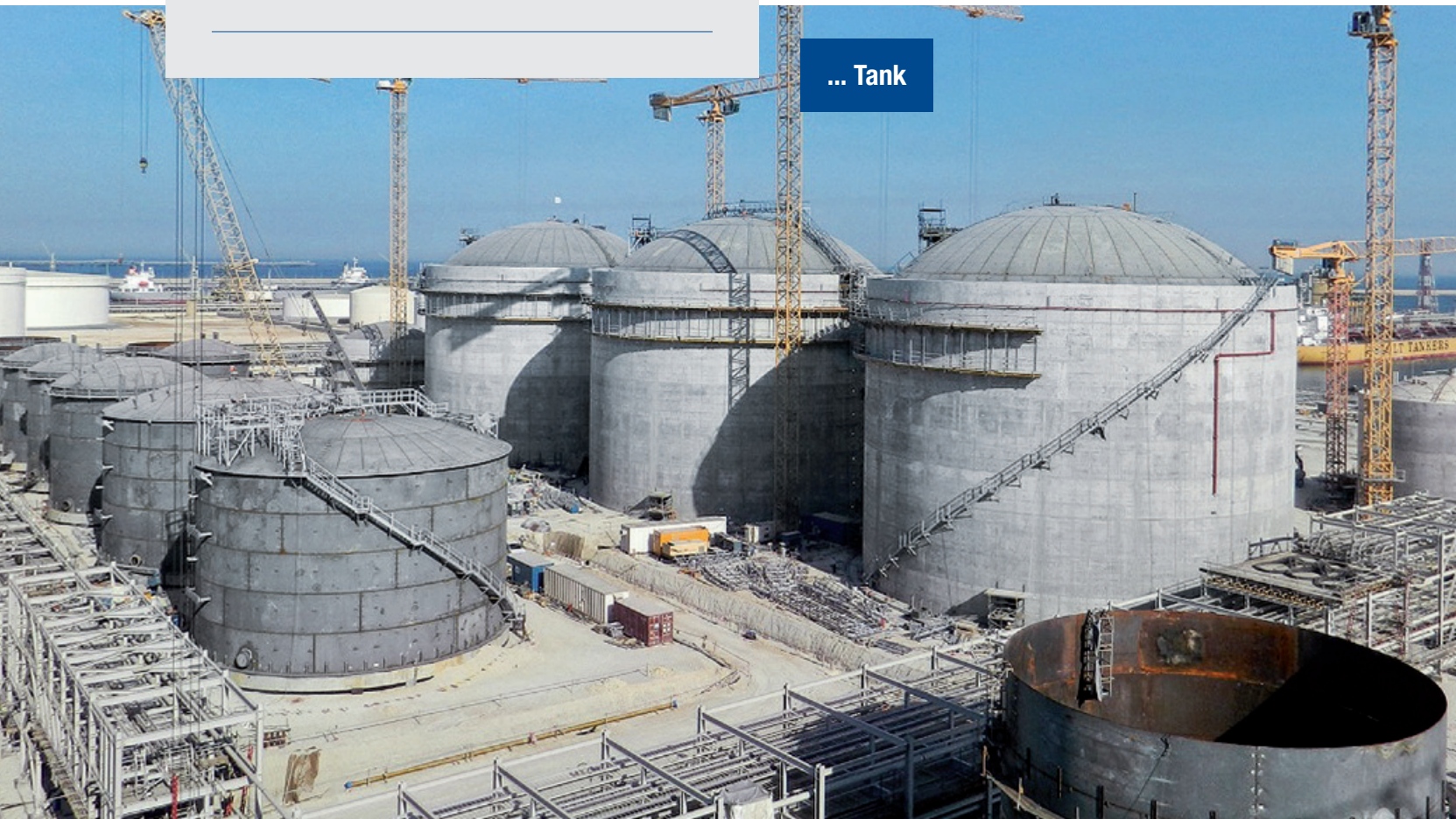



... Silo

Special challenges for construction from ...

- working in tight spaces requires precise plans for workflow and schedules
 - stringent requirements for the surface of interior silo walls relative to adhesion properties
 - complex shape of funnel structure
 - shoring of the silo slab for cast-in-place concreting
 - quick pouring operations for intricate structures because of low concrete volume
-

essential structures in cast-in-place concrete:

- foundations
- silo walls
- funnel structure
- slabs



Freeport LNG Tanks

On remote Quintana Island, two liquid gas tanks with 80 m diameter each were built quickly and smoothly by using 224 climbing units MF240 and self-compacting concrete SCC.

Challenge:

- tight schedule – limited resources for on-site assembly and typical cycles
- high degree of reinforcement and a multitude of horizontal and vertical pre-stressed channels
- production of concrete directly on site as the distance to nearest mixing plant is long



Location: Quintana Island, Texas, USA

Construction work: Technip USA, Zachary Construction Corporation, Saipem SA

Type of structure: Liquefied natural gas tank

Facts: 2 tanks with 80 m diameter each

Project solution:

- shorter lead time on site thanks to pre-assembly of 5,000 m² Large-area Top 50 and 224 climbing units MF240 in the nearby Doka branch
- fast repositioning by crane as climbing scaffold and formwork are lifted as a single unit
- Top 50 formwork solution designed for self-compacting concrete with special requirements for density and high fresh-concrete pressure

Products used:

Climbing formwork MF240, Large-area formwork Top 50, Formwork planning, Formwork Instructor

Construction time: 2005 – 2008

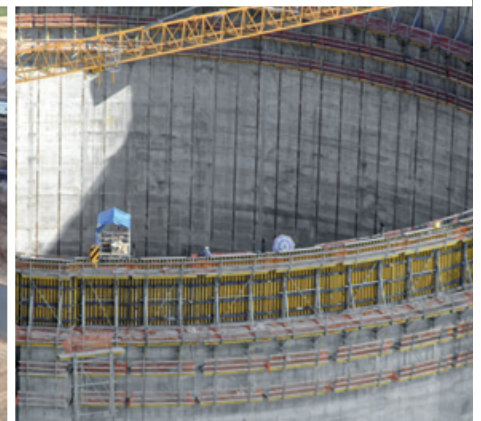



Sinopec Guangxi Beihai LNG Terminal

Guangxi is one of the fastest growing regions in all of China. In order to meet the growing need for energy, the Chinese government signed a 20-year contract with Australia for delivering 4.3 million tons of liquefied gas annually. Doka supplied the formwork solution for the required tanks, from foundation to top pressure ring.



Challenge:

- differing pouring heights in each casting section
- client-owned equipment to be re-used
- high vertical loads of the projecting top pressure ring
- built-in structures and pipes, some of which also protrude into the formwork

Location: Beihai City, China

Construction work: Huaxing: 2 tanks, Jinding: 1 tank, Zhongyuan oilfield: 1 tank

Type of structure: Liquefied gas tank

Facts: 4 tanks

Project solution:

- savings of time and money for assembly and typical application as only one formwork set is used
- short lead time thanks to incorporation and fast availability of customer-owned materials
- vertical loads from the top pressure ring are safely transferred due to formwork solution with separate compression bracket
- smooth forming of all structures as all built-in parts and pipes were considered for the formwork design

Products used:

Climbing formwork 150 F; Large-area formwork Top 50

Construction time: 2013 – 2014



Tilbury LNG Project

The primary purpose of the Tilbury LNG tank is to cover peak gas demand in the lower British Columbia mainland. The tank is roughly 35 m high with a 47-m diameter. Doka engineering experts began cooperating with the construction company early and were therefore able to contribute innovative ideas for accelerating the construction process.



Location: Delta, Canada
Construction work: Bechtel Canada Co.
Type of structure: Liquid gas tank
Facts: Tank with roughly 47 m diameter

Project solution:

- best possible project coordination even across great distances thanks to Doka's North American regional team with branches in the US and Canada
- smooth construction workflow due to formwork concept with one-sided operation with particular consideration for installation parts and steel construction located on the inside
- smooth project start with training for the site crew from experienced Formwork Instructor
- rapid availability and just-in-time delivery of the required formwork equipment from nearby Doka branch

Products used:

Climbing formwork MF240, Large-area formwork Top 50

Construction time: 2014 – 2016

Challenge:

- Bechtel design team location in Houston, Texas and construction site in Delta, British Columbia
- advancing steel construction inside
- short lead times on the site



Studstrup Power Plant

A new silo for heating with biomass was added to the Studstrup coal and oil power plant that went operational in 1968 in Denmark. This is the first milestone toward a CO₂ neutral future for Aarhus by 2030.

Challenge:

- installing 700 t reinforcement, most of it in the form of prefabricated curved reinforcement cages
- limited lifting capacity with only two tower cranes
- rapid construction progress with minimal manpower resources



Location: Studstrup, Denmark
Construction work: NCC Construction Danmark A/S
Type of structure: Oil-coal-biomass power plant / silo
Facts: Silo with 70 m diameter for 100,000 m³ biomass

Project solution:

- project solution optimised for six pouring sections per ring for rapid construction progress with 2.5 sections per week
- formwork concept consisting of Large-area formwork Top 50 and Climbing formwork MF240 designed to afford optimum support for rapid reinforcement installation
- few crane lifts and crane busy for only a short time as climbing scaffold and formwork are lifted as a single unit
- safe working conditions throughout all stages of construction thanks to integrated access ladders and all-round enclosed working platforms
- minimal labour cost for formwork operation: forming and stripping as well as repositioning were accomplished with only two workers and one crane operator

Products used:

Climbing formwork MF240, Large-area formwork Top 50, Working scaffold Module

Construction time: 2013 – 2015

Concrete monitoring with Concremote

Measuring strength and temperature of concrete in real time

Concremote enables concrete strength and concrete temperature to be monitored in real time. It uses the weighted maturity method (as developed by de Vree) to provide reliable, standards-compliant information online. This facilitates targeted management of the forming and CIP concreting operations and helps ensure the necessary quality.

reliable measured values directly from the concrete for quick response

optimisation of construction processes thanks to real-time monitoring of concrete strength

targeted management of forming and cast-in-place concrete operations



Proof of thermal stresses in structure to prevent cracking:

Concremote can depict relationships (e.g.: core temperature to surface temperature) of all measuring points to one another and send out real-time notifications if thresholds are exceeded. Graphs are generated automatically and can be viewed in real time.

Proof of concrete strength for safe climbing process:

Concremote logs concrete strength and issues notification when the level necessary for resuming climbing operations is reached.



Temperature development

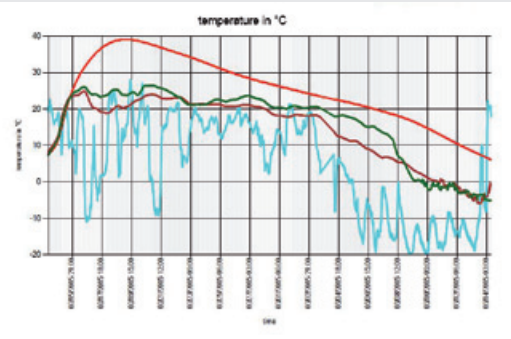

Display of delivery, maximum and minimum temperatures from various positions

Data analysis

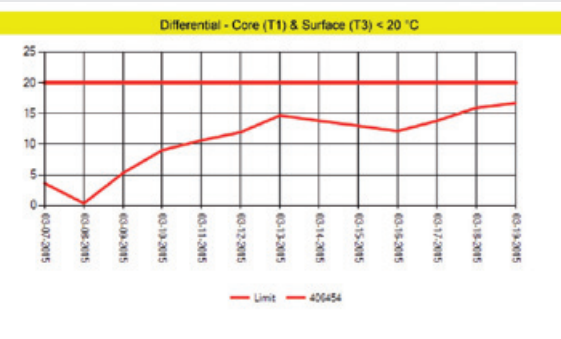

Evaluation of ratios (e.g.: core-to-edge temperatures < 20 C°)



Concremote slab sensor:

- easy installation
- no lost parts
- reusable



Concremote cable sensor:

- can be used anywhere due to different cables
- up to three concrete measuring points per sensor



Concremote calibration box:

- calibration for curing method
- testing concrete behaviour prior to construction start
- finding the most suitable concrete formula



To ensure that construction progresses rapidly and steadily, the individual pouring sections at the **Canadian Muskrat Falls Project** are monitored by 45 sensors.

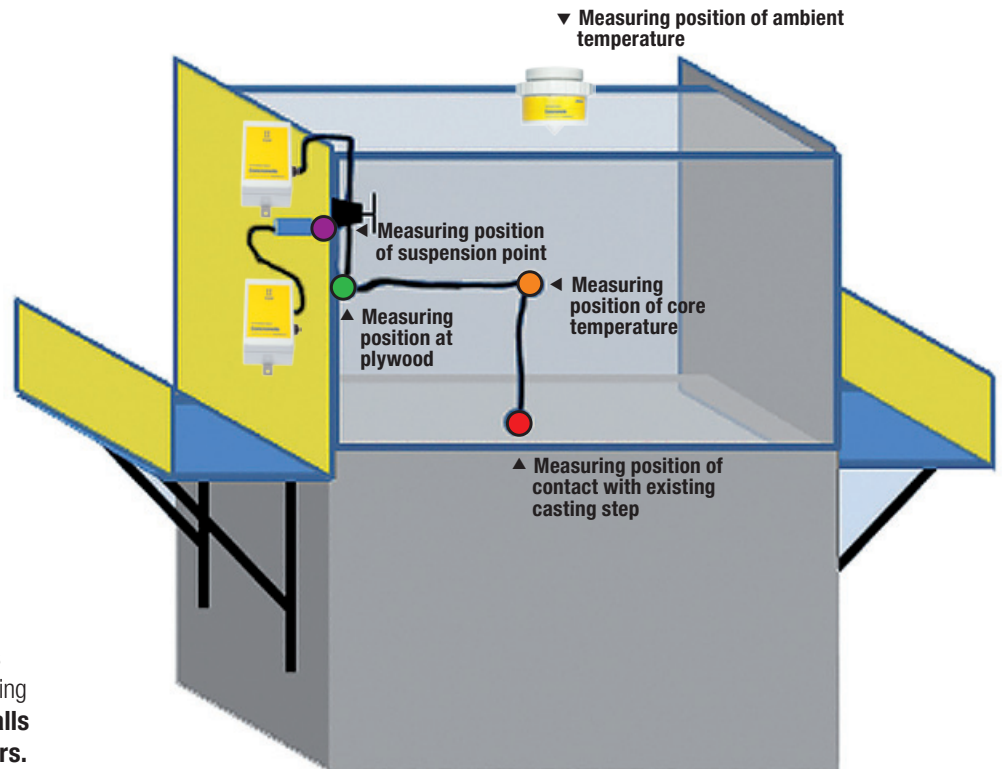

Strength development

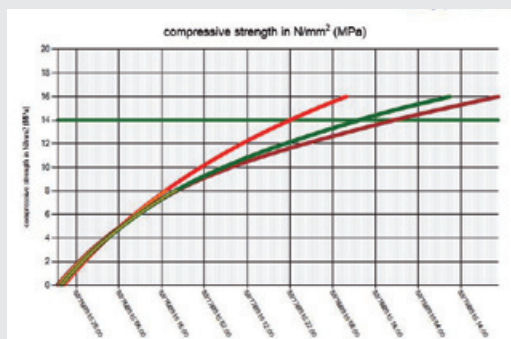

Calculation of compressive strength development curve using actual temperature data. Message once target strength is reached

Efficient project solution thanks to savings of follow-on costs, economical data analysis and faster data availability



Data can be accessed in real-time via web interface. Notifications with desired criteria

Climbing systems

Climbing formwork for a wide range of requirements - with or without cranes

With its modular systems based on decades of experience with different tasks, Doka provides the right climbing solution. Whether crane-dependent or crane-independent, they are all characterised by the highest safety standard combined with high efficiency and safe handling.

Crane-dependent climbing

not structure-guided

The shaping wall formwork and climbing scaffold are firmly connected and quickly lifted as a single unit by crane. The different versions of the system all offer ease of working with trouble-free adaptation to different uses.

- **Climbing formwork MF240** – for structures of any shape and height; platform width is 2.40 m
- **Climbing formwork 150F** – for structures with vertical walls; platform width is 1.65 m
- **Climbing formwork K** – the uncomplicated climbing formwork consisting of pre-assembled Folding platform K and formwork panel
- **Shaft platform** – the formwork for inside shafts



- **Dam formwork D12, D15, D22 and D35** – used for single-sided mass concrete structures with block heights up to 5.0 m
- **Climbing formwork for wind turbines** – non-tied steel formwork for construction of the tower



structure-guided

Because it is guided on the structure at all times, the climbing system can be repositioned at higher wind speeds. As a result the climbing process is less dependent on wind conditions, faster and safer.

- **Guided climbing formwork Xclimb 60** – for structures of uncomplicated shape and any height with guiding shoes that minimise the physical effort needed

Crane-independent climbing

structure-guided and with mobile hydraulic or electric drive

Climbing systems with mobile drives are the first step into the world of automatic climbing. They free-up the construction crane, are guided on the structure at all times and thus can be repositioned even at high wind speeds.

- **Automatic climbing formwork Xclimb 60** – for structures of uncomplicated shape and any height with innovative mobile hydraulic system
- **Cooling tower formwork SK175** – the automatic climbing formwork for a 1-day-cycle on hyperboloid-tower builds



structure-guided and fully hydraulic

The built-in hydraulic system allows for simultaneous repositioning of large platform gangs without open drop-off areas. Generously dimensioned and high-load-capacity working platforms provide maximum support for the construction workflow.

- **Automatic climbing formwork SKE plus** – for universal use with system versions of 5 and 10 t per lifting unit
- **Automatic climbing dam formwork** – for mass concrete structures; combination of dam formwork and automatic climbing formwork SKE plus

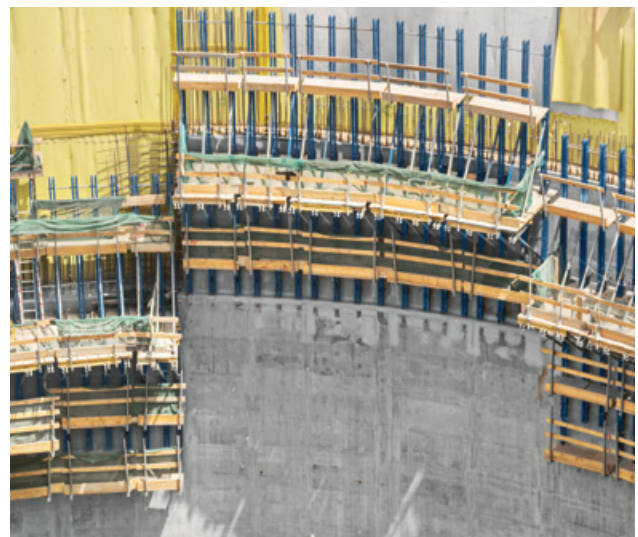

Wall systems / Large-area formwork

Tailor-made large-area formwork for all shapes and loads

Customised formwork with freely selectable form-tie spacing for optimal adaptation to the specific structure

Freely selectable form ply and joint pattern for adaptation to the specific reuse number and architectural requirements

Any pouring rate, as it can easily be dimensioned for any fresh-concrete pressure



Large-area formwork Top 50

The standard Large-area formwork for a multitude of tasks. The comprehensive modular system permits adaptation to structures of any shape and to any loads.

Large-area formwork placed on its side

Shaped timbers are used to adapt the Large-area formwork Top 50 positioned on its side precisely to the requirements of the geometry on the build of the SEC Trunk Sewer project in Ontario.

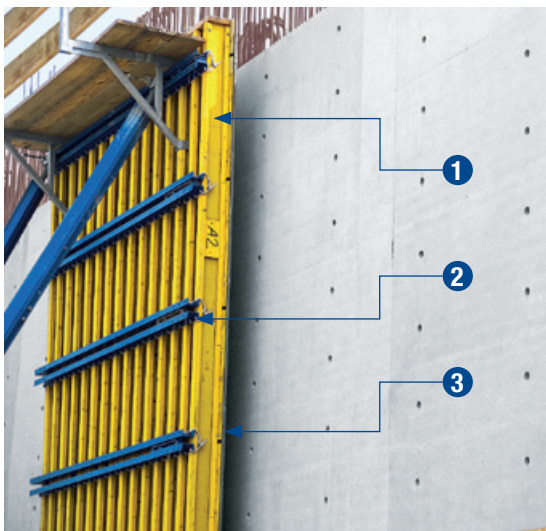

Large-area formwork in detail

Depending on the loads expected, formwork beams **1** and multi-purpose walings **2** are spaced closer together or further apart. The form ply **3** is freely selectable to meet a wide range of requirements.



Doka Working scaffold for reinforcement work



Doka's Working scaffold is the ideal add-on for all Doka formwork systems at your construction site: it ensures safety and speed during reinforcement operations.

High-tensile connections allow for rapid repositioning of complete units in a single crane cycle. Additional assembly and disassembly operations are eliminated.

It is also suitable for use as a stair tower or a mobile scaffold tower.

Supporting construction frame

Supporting construction frames transfer forces generated during pouring operations safely via diagonal anchors. They are helpful anywhere structures cannot be used for anchoring wall formwork panels. Doka supporting construction frames can be combined with Doka large-area and framed formwork systems without any problems.

Supporting construction frame "Variable"

The standard solutions for pouring heights up to 4.05 m. Parallel SC frames are easily installed and moved by hand and consist of standard multi-purpose walings with additional parts.



Supporting construction frame Universal F

They are the solution for pouring heights from 3.0 to 12.80 m made of ready-to-use parallel SC frames. As an alternative to crane lifting, they can be repositioned using travelling gear.



Wall systems / Framed formwork

Forming with standard panels in various sizes

Pre-fabricated framed formwork panels with consistent 15-cm increment-grid for adaptability to widely differing requirements

High reuse numbers thanks to galvanised, powder-coated framed formwork panels with Xlife formwork sheet and plastic-enhanced surface for a long lifespan

Designed for 80 kN/m² fresh-concrete pressure for fast pouring

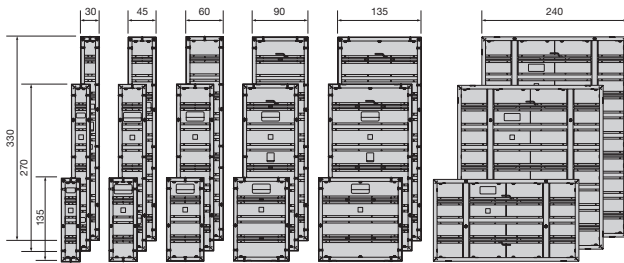

Framed formwork Framax Xlife

The high-performing steel-framed formwork for all-round use. It takes only a few panels to achieve a consistent 15-cm increment-grid, no matter whether the panels are stood upright or on their sides. All fixings and accessories fit seamlessly into this increment-grid, making them convenient to use on the job.



Framed formwork Framax Xlife in detail

Ingeniously co-ordinated panel formats up to 2.40 m wide and 3.30 m high help you make optimum use of formwork commissioning quantities.

Framed formwork Framax Xlife plus

The new framed formwork with tie rod system that can be operated from one side. The centrepiece of this wall formwork is the Framax Xlife plus form tie. It can be operated from one side and saves up to one third in forming and stripping time. Due to its conical shape, there is no need for jacket tubes and cones.



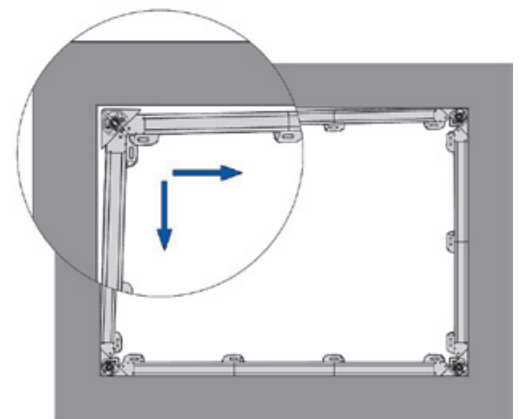

◀ Framax Xlife in combination with Automatic climbing formwork Xclimb 60 and Shaft platform at the Timelkam combined-cycle gas turbine plant in Austria.

▲ Shaft formwork with Framax stripping corner I

Framax stripping corner I is designed especially for shafts and easily combined with Doka framed and wall formwork. It allows for forming and stripping without using the crane, simply by operating easy-to-turn spindles using a length of rebar or the convenient ratchet. It is repositioned in one piece, thus saving crane-time. Doka's Framax stripping corner I is also suitable for use on pilasters and as an inside corner for wall formwork.

Doka column formwork

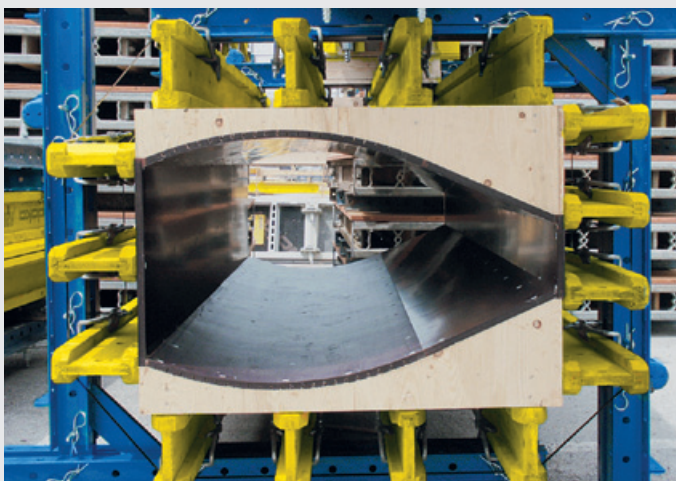

- **Column formwork Top 50**
for CIP columns of any shape and height
- **Column formwork Framax Xlife**
for rectangular and square CIP columns
- **Column formwork KS Xlife**
the column formwork with folding mechanism
- **Column formwork RS**
the steel formwork for round column cross-sections
- **Custom solutions made of steel**
adapted individually to your project requirements

General conditions for horizontal structures

The right combination of shoring system and superstructure

The working method selected plays an important role when it comes to efficient production of a structure. Properties of the structure to be built are a deciding factor in choosing the right shoring system. Hence, superstructure and shoring system always have to be considered together in the selection process.

Assembly / Disassembly

Load bearing towers can be preassembled horizontally on the ground or in the vertical way. Vertical assembly and/or disassembly requires special attention to the aspect of workplace safety. The process of setting up and dismantling floor systems on reshoring props varies depending on the system.



General framework conditions

These include factors such as space for repositioning, working and storage areas, type and condition of footing or reuse for other structures.

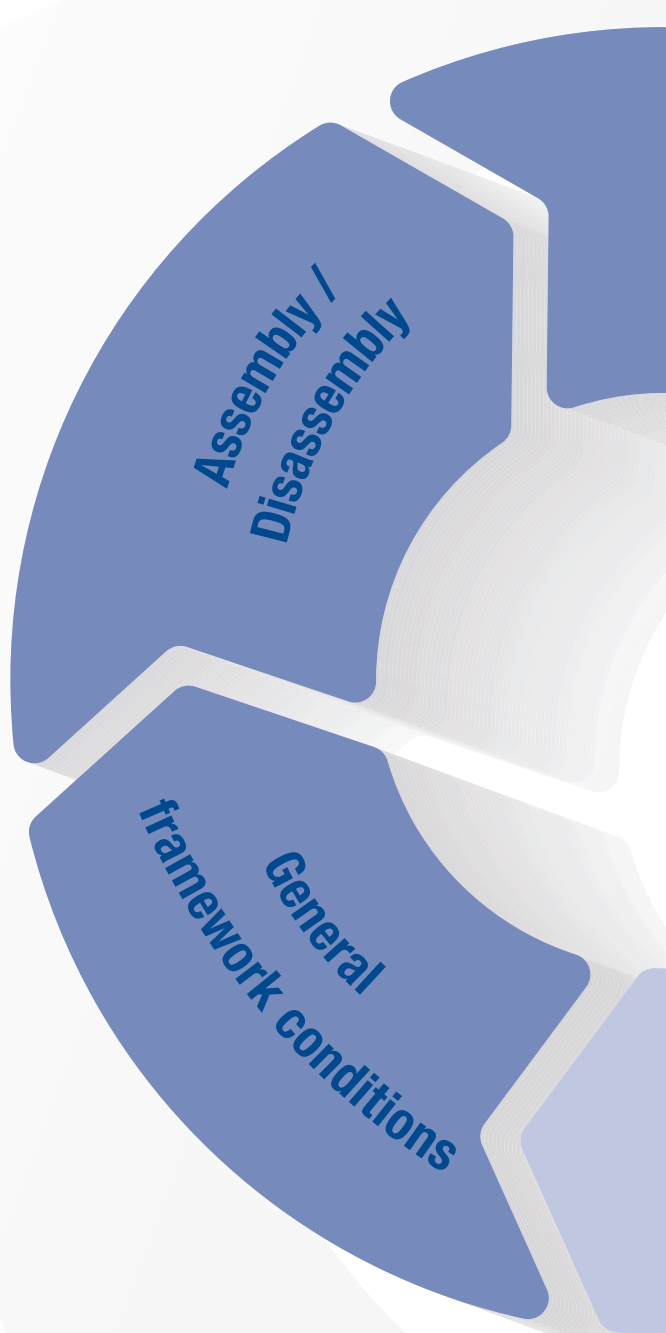



Number of uses

Solutions that combine a shoring system with a firmly attached top construction like table-forms make sense for repetitive applications. If not used repeatedly, a better solution is to assemble and disassemble a top construction by hand.

Repositioning

Repositioning depends on the actual shoring system. The distinction here is between tower units made of load-bearing towers and floor systems on props.

Shoring height

Depending on shoring height, both load-bearing towers and/or floor props can be used as shoring systems. For selection of shoring systems, the loads to be transferred need to be taken into account.

The taller the shoring height, the more important is the connection to existing structures to ensure shoring system stability.

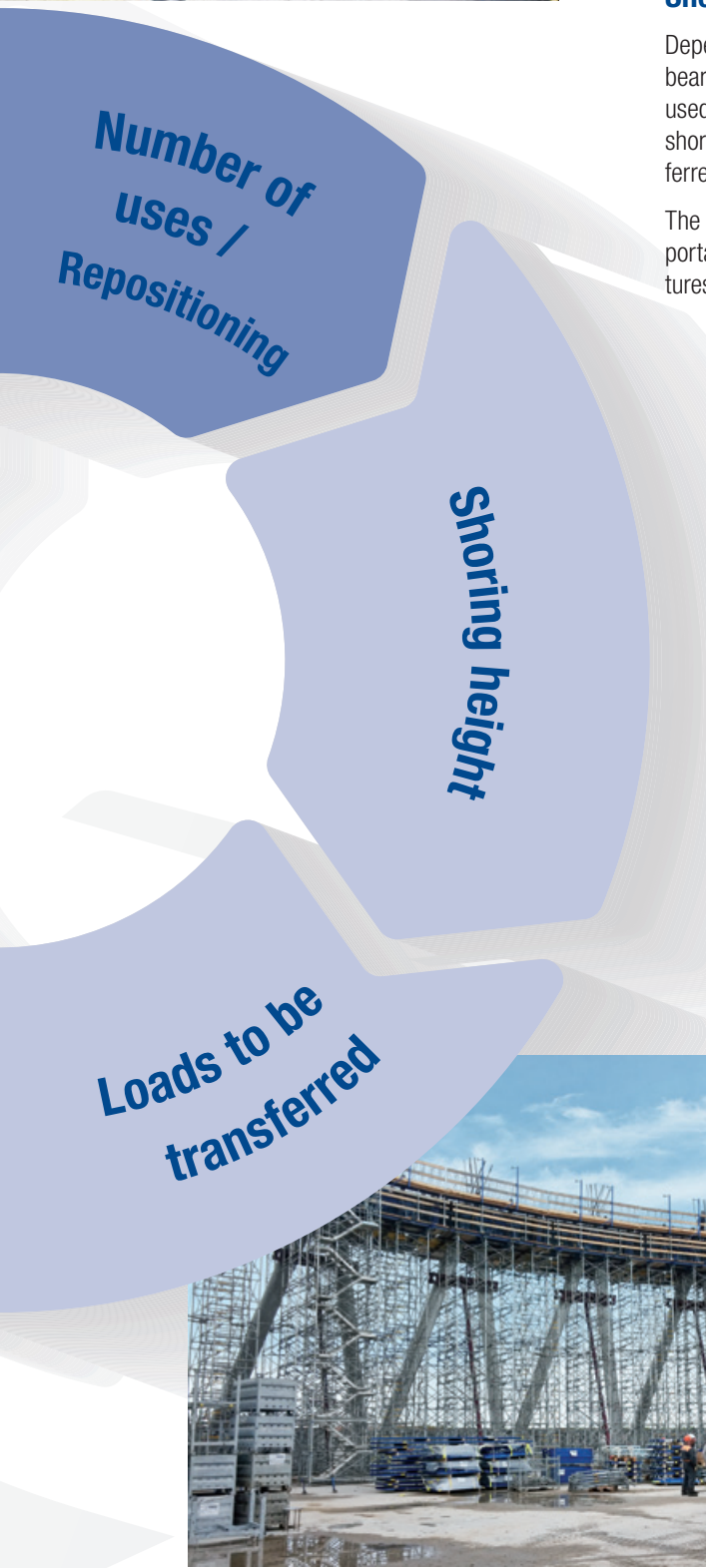

Example: turbine stand

Challenges

- Shoring height: 9.2 m
- Floor thickness: 3.1 m
- Stringent requirements for accurate position and dimensional stability for turbine installation

Solution

- Load-bearing tower Staxo 100 tower units with tableforms made of multi-purpose waling and formwork beams optimised for geometry and load



Loads to be transferred

Crucial factors for dimensioning are thickness of horizontal structures, dead weight of concrete, required live loads as well as horizontal loads like wind loads.

In addition to the loads impacting the shoring system, the stability of the subgrade plays an essential part in overall stability.

Load-bearing towers and floor props

The safe way to handle heavy loads

Load-bearing systems up to 100 kN per leg

- **Load-bearing tower Staxo 100** – the high-performing and extra-fast shoring system with built-in safety
- **Load-bearing tower d3** – the efficient system combined with high load capacity designed specifically for overseas market requirements
- **Load-bearing tower d2** – the proven shoring system for many different uses up to 65 kN per leg

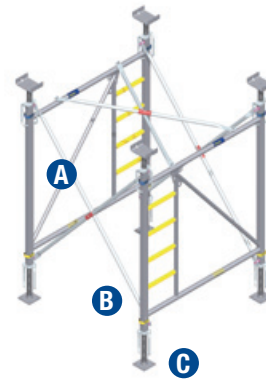

Load-bearing systems up to 45 kN per leg

- **Load-bearing tower Staxo 40** – the lightweight shoring system for ergonomic working

Doka load-bearing towers in detail:

Depending on expected load and required height, **A** frames, **B** diagonal crosses and **C** screwjack heads and feet are combined to produce a load-bearing tower. ▶

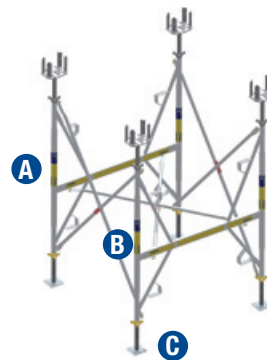

Floor props

- **Floor prop Eurex top** – the first floor prop with impact protector; load capacity of at least 20 and/or 30 kN acc. to EN 1065 – class D/E
- **Floor prop Eurex 20 eco** – high load capacity and safe handling; permitted load capacity up to 36.7 kN
- **Floor prop Eurex 60** – the heavy-duty aluminium floor prop with 60 kN load capacity up to 5.50 m extension length



Floor prop Eurex top in detail: ▶

Built-in details such as the impact protector **A**, the adjusting nut with special thread geometry **B** and patented hole numbering **C** ensure easy handling and a long lifespan in the rough-and-tumble of everyday work on the site.

Floor formwork

For all fields of use and tough specifications

Tableforms



Tableforms are ideally suited for rapidly forming large floor areas. Depending on specific use, the generously dimensioned repositioning units are combined with Doka floor props or a Doka load-bearing tower system.

- **Dokamatic table** – the pre-assembled, innovative tableform to support heavy loads
- **Dokaflex table** – the proven tableform with uncomplicated system design
- **Custom tables** – project-specific table formats with choice of plywood sheeting, primary and secondary beams

Panel floor formwork



Panel floor formwork systems are hand-set formwork systems designed for quick set-up and dismantling as well as easy shipping.

- **Dokadek 30** – the beam-less, hand-set formwork system in lightweight steel design faced with a wood/plastic composite sheet

Forming operations are carried out safely from the ground level without walking on the floor formwork

Timber-beam floor formwork



Timber-beam floor formwork systems are characterised by their easy adaptation to any layouts. They are set up and dismantled by hand and are especially suitable for closed spaces.

- **Dokaflex** – the hand-set system that is quickly set up thanks to the markings on the formwork beams
- **Dokaflex 30 tec** – the timber-beam floor formwork with the heavy-duty box beam I tec 20 for optimised equipment use

Doka Safety Systems

Various systems for your safety on the site



Stair tower 250

The sturdy, stable stair tower can be put together very quickly from frames and pre-assembled stairway elements. Intermediate exits permit safe access to all work-deck levels.

universal usability thanks to their versatility and heights of up to 100 m

easier working conditions for your crew thanks to ergonomic design and less physical effort for ascending and descending

practice-oriented assembly because the basic structure is simple with only a few individual parts

Ladder system XS

Access systems with integral ladder cages can be attached to Doka wall and column formwork in a few simple steps. These safety accessories can be mounted to the formwork while it is still flat on the ground.

Access system and cage for safe and fast working
for a smooth and safe workflow
simple to deploy – anywhere





Edge protection system XP

This system is the universal safety solution for all edge protection needs. It fits in ideally with all Doka systems whether wall or floor formwork – for safeguarding floor edges or as guardrail systems on the structure shell.

complete guardrail system thanks to only one upright for all types of edge protection from 1.20 m to 1.80 m high

tested safety through EN 13374 and GS verification

long lifespan thanks to hot-dip galvanising and high stability

Guard rails

Doka guard rails provide a fast and very safe way of putting up safety railings. Guard rails can be deployed along floor edges, floor openings or other fall-hazard locations, or as opposing railing with wall formwork.

quick and easy to assemble

long lifespan thanks to sturdy design

speeds up workflows thanks to increased sense of safety among crew



Safe measuring of the form-tie load

For monitoring formwork pressure in crucial structures or high pouring speed



_Understanding: Creating a project sequence that is safe

From planning stage through to project completion, Doka experts provide help with professional consultation in case of any questions. Safe use of formwork systems is achieved not only by the system, but even more so by using their structures correctly. Documents, practical tips, training right on site and verified systems support a safe project sequence.

Pre-assembly Service

Special factors and structural requirements frequently call for an individualised approach. Doka's solutions include customised formwork, pre-assembled working platforms or wall formwork systems assembled at Doka Pre-assembly Service centres. This reduces assembly effort and need for space on your construction site.



Certified formwork systems

Certificates and awards issued for standard-compliant Doka formwork systems are your guarantee for high quality and safety. Additionally, all products are tested regularly at Doka's Test Center in Amstetten.



European Committee for Standardization
Comité Européen de Normalisation
Europäisches Komitee für Normung



Safety with Doka & Operations scheduling

- Pre-assembly Service
- Certified formwork systems
- Documentation
- Training / Operation licence
- Method statement



Documentation

The following technical documents ensure that your project solution can be calculated, configured, commissioned and dismantled safely and as intended:

- Planning documents
- Static calculations
- User information
- CE-compliant operating instructions
- Safety posters / checklists
- Application videos



Training / Operation licence

Doka offers you detailed product and system training. All persons putting Doka automatic climbing formwork such as Doka cooling tower formwork SK175 into operation need special knowledge which can only be imparted in a separate training programme (operation licence).

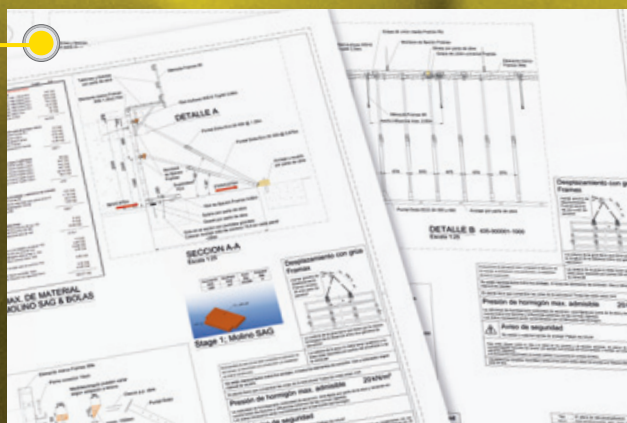

Method statement

This technical description is to be considered supplemental documentation focused on a smooth construction workflow. It includes information such as practice-oriented and easy-to-understand drawings and explanations for safe formwork handling.

_Understanding the importance of time: Logistics network for fast global availability

To ensure a smooth construction workflow, the entire logistics network has to mesh like clockwork. Doka logistics experts plan and provide on-site support of deliveries and return shipments, site logistics and much more.

Just in time transport arrangements

Precisely scheduled deliveries to the right place on the site simplify the construction workflow on sites with different building project sections and a multitude of formwork equipment. Doka optimises standard as well as special shipments with the necessary routine thanks to worldwide logistics distribution centres.



Logistics

- Just in time transport arrangements
- Site Logistics
- Formwork Return
- Cleaning and Reconditioning
- myDoka



Site Logistics

Energy projects are sites that require high volumes of materials. Accordingly, logistical control of formwork in construction operations is challenging. One way Doka can support you is with logistics concepts for intermediate storage and repositioning of formwork.



Formwork Return

The rental formwork is inspected jointly right on the site or at the Doka branch. This way any damage and follow-up costs are defined together and transparently listed in a report.



Cleaning and reconditioning

At Doka Reconditioning, your formwork is cleaned and perfectly reconditioned in keeping with Doka quality standards. Any needed repairs are carried out and replacement parts properly installed. This extends the life span and ensures safety and reliability for the next formwork assignment.



myDoka

myDoka is the electronic customer portal for your project-specific data. myDoka provides you with 24/7 access to your latest inventory and transaction data, giving you an overview of all key information. From planning to evaluation, from contract all the way through to controlling; all your data are displayed at a glance and always up-to-date.

_Understanding what happens on site: We are where you are.

We back up our promise on site. When it is time to put the made-to-measure formwork concept for your energy project into practice, our on-site formwork experts are by your side. This is how we ensure that construction workflows and schedules can be kept and the project successfully realised.





Formwork pre-assembly

Formwork utilisations that are out of the ordinary require specially trained personnel for pre-assembly, operation and dismantling. Doka experts handle these tasks for you directly on site. To you this means a safe and smooth process right from the start.



Formwork inspection as assembled

Along with you, the Doka Formwork Instructor or technician will inspect your construction site for correct formwork assembly. Faulty utilisation is identified immediately and can be corrected before pouring operations begin.



Formwork Instructor / Technician

The Doka Formwork Instructor is a specially trained and experienced practitioner on the site. He provides you with support in effective and safe formwork use on the construction site. If necessary, Doka specialists also deal with technical, commercial and logistical issues on-site.



Customer Service

Proper servicing and preventive maintenance of electrical and hydraulic formwork equipment by Doka specialists ensures perfect function in the ongoing site operations.



Understanding what the future holds.

We invest every day in further developing our products and services so we can continue to always find the best solution for our customers. Valuable information is gathered in each and every project and incorporated as soon as we work on the next one. Thus we are equipped for the future and always ready to take our customers to the next level.







 twitter.com/doka_com

 facebook.com/dokacom

 youtube.com/doka